

IAT 884 – Tangible Computing  
Workshop 1  
Basic Electronics

**Preparation:**

Read *Physical Computing*: Introduction, chapter 1, chapter 2 (p. 11-25 only), and chapter 3.

You can find it online here: <http://proquest.safaribooksonline.com.proxy.lib.sfu.ca/159200346X>

**In Class Exercise**

For this workshop you will be building some basic circuits. You will also draw a schematic diagram representing each one.

You do not need to solder these circuits, however if you feel confident and wish to try using the soldering gun you are welcome to.

**Material (Provided in your kits)**

Bread Board  
9 Volt Battery  
1 x Battery Connector  
1 x LED  
1 x Switch  
1x 1k Ohm Resistor  
1x 390 Ohm Resistor  
1 x Photo Resistor/ Flex Sensor/ Other Sensor  
Wire: Solid Core

**Tasks:**

1. Build circuits to accomplish each of the following tasks:
  - Light an LED
  - Use a switch to control the state of an LED
  - Dim an LED by incorporating it into a voltage divider circuit. (See attached worksheet how to build this). \*
  
2. Draw a schematic diagram representing each circuit

\* Definition of Voltage Divider: P. 95 in Physical Computing

\* Example: [people.clarkson.edu/~svoboda/eta/designLab/VoltageDividerDesign.html](http://people.clarkson.edu/~svoboda/eta/designLab/VoltageDividerDesign.html)

# Basic Circuits

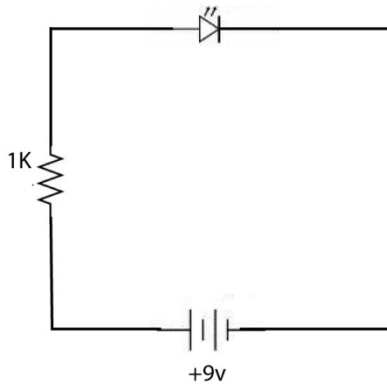

Basic LED Circuit

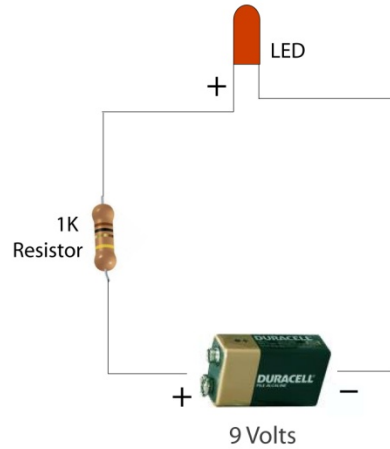

LEDs require a resistor to keep them from burning out immediately. To determine the value of this resistor you use the following formula.

The resistor value R is given by:

$$R = (V_S - V_L) / I$$

$V_S$  = supply voltage (9 Volts in this case)

$V_L$  = LED voltage (~ 2V for Red LEDs)

I = LED current (~ 20mA). Your circuit must provide more current than your components require.

So, if we plug our values into the equation we get:

$$R = (9V - 2V) / 0.02A = 350\Omega,$$

Anything greater than this value is suitable, the higher the value of the resistor, the dimmer the LED will glow. You could choose a 390 $\Omega$  resistor, but we will use a 1K $\Omega$  resistor.

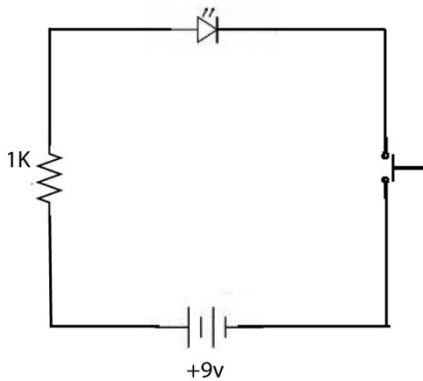

LED Circuit with Switch

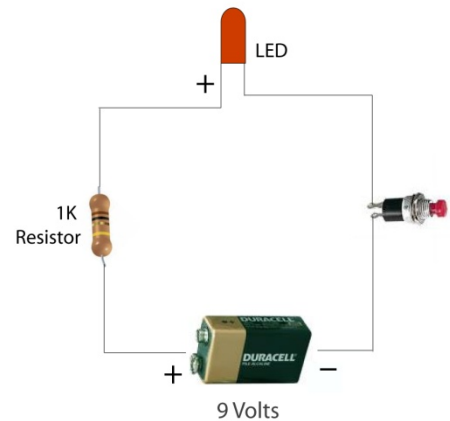

# Voltage Divider Circuits

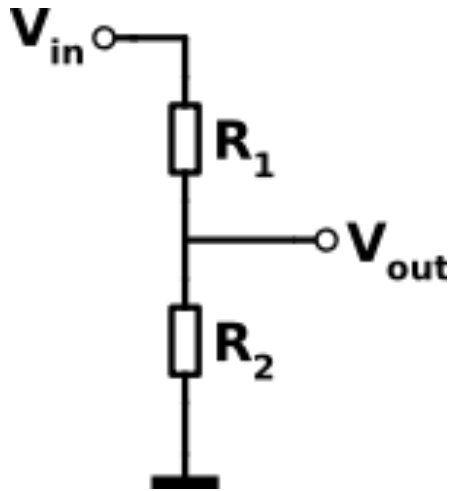

Voltage Divider Schematic

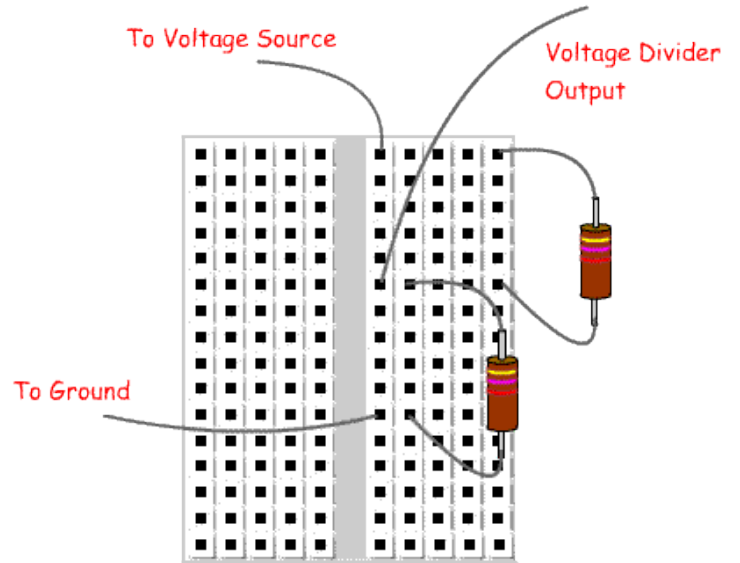

Voltage Divider Circuit on a breadboard

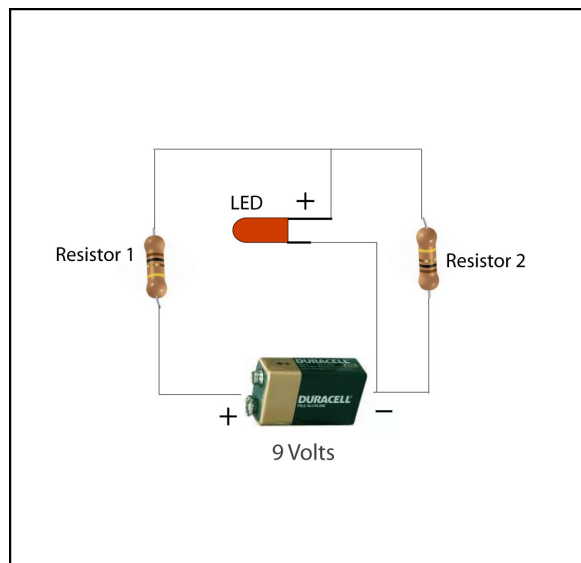













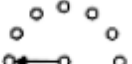

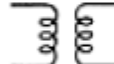





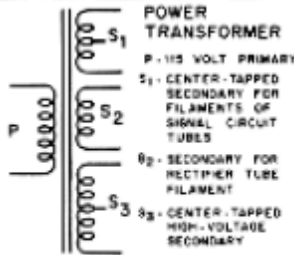

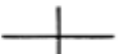





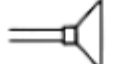

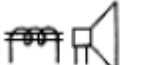
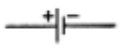

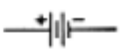

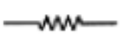

Voltage Divider Circuit with an LED

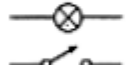
## STANDARD SCHEMATIC SYMBOLS

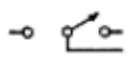
The symbols below are standard in radio, TV and electronics diagrams. Popular components are represented. An industry-wide attempt is being made to standardize schematic diagrams. All current diagrams will be enough like these to easily identify the components. Note the two methods used to indicate a wire connection and a crossover. Both are in common use, but the

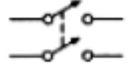
curved wire crossover and dotted connection is preferred.

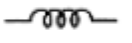
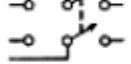
The symbol for a ground point may indicate an actual connection to the metal chassis, or a connection to a common lead, usually the B- voltage point. All ground points may usually be assumed to be connected together electrically.

	ANTENNA (AERIAL)		IRON CORE CHOKE COIL		SWITCH (ROTARY OR SELECTOR)
	GROUND		R.F. TRANSFORMER (AIR CORE)		DIODE
	ANTENNA (LOOP)		A.F. TRANSFORMER (IRON CORE)		LIGHTNING ARRESTER
	WIRING METHOD 1 CONNECTION		POWER TRANSFORMER P-115 VOLT PRIMARY S <sub>1</sub> -CENTER-TAPPED SECONDARY FOR FILAMENTS OF SIGNAL CIRCUIT TUBES S <sub>2</sub> -SECONDARY FOR RECTIFIER TUBE FILAMENT S <sub>3</sub> -CENTER-TAPPED HIGH-VOLTAGE SECONDARY		FUSE
	NO CONNECTION				PILOT LAMP
	WIRING METHOD 2 CONNECTION		FIXED CAPACITOR (MICA OR PAPER)		HEADPHONES
	NO CONNECTION				LOUDSPEAKER, P. M. DYNAMIC
	TERMINAL		FIXED CAPACITOR (ELECTROLYTIC)		LOUDSPEAKER, ELECTRODYNAMIC
	ONE CELL OR "A" BATTERY		ADJUSTABLE OR VARIABLE CAPACITOR		PHONO PICK-UP
	MULTI-CELL OR "B" BATTERY		ADJUSTABLE OR VARIABLE CAPACITORS (GANDED)		VACUUM TUBE HEATER OR FILAMENT
	RESISTOR		I.F. TRANSFORMER (DOUBLE-TUNED)		VACUUM TUBE CATHODE
	POTENTIOMETER (VOLUME CONTROL)		POWER SWITCH S. P. S. T.		VACUUM TUBE GRID
	TAPPED RESISTOR OR VOLTAGE DIVIDER		SWITCH S. P. D. T.		VACUUM TUBE PLATE
	RHEOSTAT		SWITCH D. P. S. T.		3-ELEMENT VACUUM TUBE (TRIODE)
	AIR CORE CHOKE COIL		SWITCH D. P. D. T.		ALIGNING KEY OCTAL BASE TUBE